



POOL BREAKDOWN



ROYAL RETREAT ~ PS 24' x 12' OVAL 52"

RESIN TOP RAIL - RESIN VERTICAL

√	QTY	CARTON NUMBER	CARTON DESCRIPTION
	1	5-9942-834	ASSEMBLY PACK CARTON
	1	5-9816-725	TOP RAIL PACK CARTON
	1	5-9710-604	VERTICAL PACK CARTON
	1	5-0568-042	SIDEWALL CARTON
	1	0-8888-206	SUPPORT BASE CARTON
	1	0-8852-600	SIDE SUPPORT CARTON
	1	5-9999-416	TOP CONNECTOR CARTON
	1	5-9116-834	SKIRT PACK CARTON



CARTON BREAKDOWN

✓	ITEM	QTY	PART NUMBER	DESCRIPTION
ASSEMBLY PACK # 5-9942-834				
	1	12	583-1070	Stabilizer Rail (Large)
	2	8	583-1071	Stabilizer Rail (Small)
	3	10	580-2408	Vertical End Cap
	4	10	580-2407	Bottom connector
	5	6	580-2409	Side vertical end cap
	7	33	545-1001	Plastic coping
	8	12	589-1133P	Bottom rail - stamped L 12
	10	4	589-1052P	Bottom rail - side - stamped S
	11	—	—	—
	12	142	330-1127	Sheet metal screw, #10 x 1/2"
	15	10	330-1075	Pan head screw #14 x 1/2"
	17	10	580-2397	Vertical tab
	20	6	510-1008	Slotted pan head machine screw #10-24 - 1/2"
	21	6	321-1025	Square nut #10-24
	23	6	580-2159	Outer connector bracket
	24	—	—	—
	—	1	573-5789	Pool Parts List
	—	1	573-4058	Installation Instructions
	—	1	— — —	Warranty Card
	—	1	573-3169	"Safety First" Booklet
TOP RAIL PACK # 5-9816-725				
	25	16	587-1742	Top Rail
VERTICAL PACK # 5-9710-604				
	26	10	341-1351	Vertical
TOP CONNECTOR PACK # 5-9999-416				
	27	16	340-2802	Top Connector
SKIRT PACK # 5-9116-834				
	28	16	340-2801	Skirt
	29	16	510-1001	#10 x 1-1/2" Slotted Pan head screw
SIDEWALL CARTON # 5-0568-042				
	30	1	5-0568-042	Sidewall
	31	1	535-1442	Protective Strip
	32	26	321-1029	1/4-20 Hex Flange Locknut
	33	26	330-1280	1/4-20 x 1/2" Grade 5 Bolt
	—	1	560-1055	Warning Sign
	—	1	573-3169	"Safety First" Booklet
	—	1	573-3498	Safety DVD

SUPPORT BASE PACK # 0-8888-206

34	6	580-1779	Skid support
35	6	580-2071	Ground support - top
36	6	580-2072	Ground support - bottom
37	6	580-1869	Pressure pad
38	6	580-1870	Pressure pad
39	6	580-1792	Btm rail locator & cover
40	36	510-1035	#12x3/4" hex washer head screw
41	24	330-1220	3/8"-16 x 3-1/2" hex head bolt
42	24	321-1069	3/8-16 hex nut
43	24	510-1018	1/4-20 x 1/2" hex head bolt - grade 5
44	24	511-1000	1/4-20 hex nut
45	36	330-1127	Sheet metal screw, #10 x 1/2"

SIDE SUPPORT PACK # 0-8852-600

46	6	580-2074	Side support
----	---	----------	--------------

EXPLODED PARTS VIEW

REMOVE PRIOR TO INSTALLATION
ONLY USE ON SIDE SUPPORTS FOR
OVAL POOLS

REMOVE PRIOR TO
INSTALLATION.
USE PLUG TO COVER
SCREW HOLE AFTER
INSTALLATION.

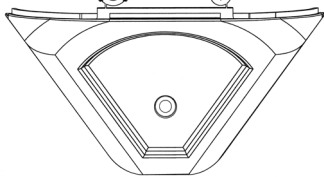

FRONT VIEW - SKIRT

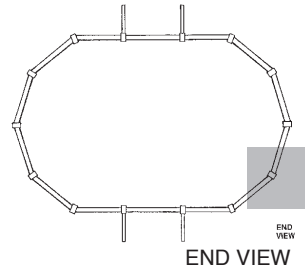
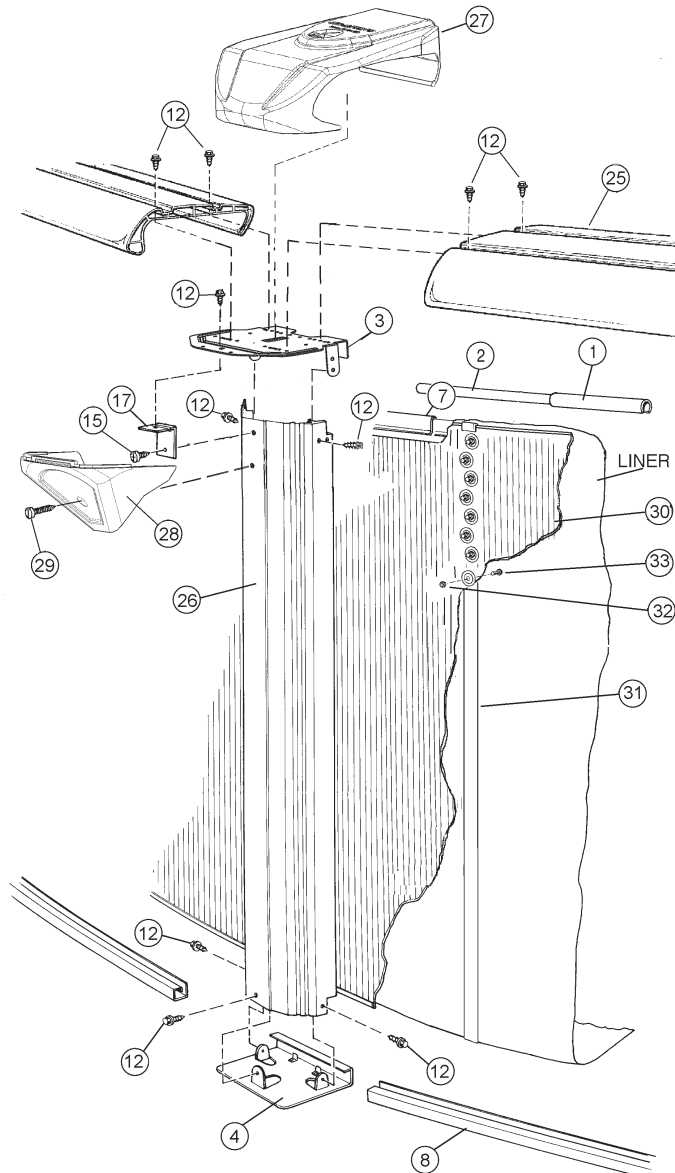

END VIEW

EXPLODED PARTS VIEW

REMOVE PRIOR TO INSTALLATION
ONLY USE ON SIDE SUPPORTS FOR
OVAL POOLS

REMOVE PRIOR TO
INSTALLATION.
USE PLUG TO COVER
SCREW HOLE AFTER
INSTALLATION.

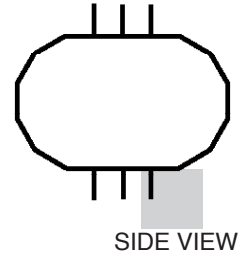

FRONT VIEW - SKIRT

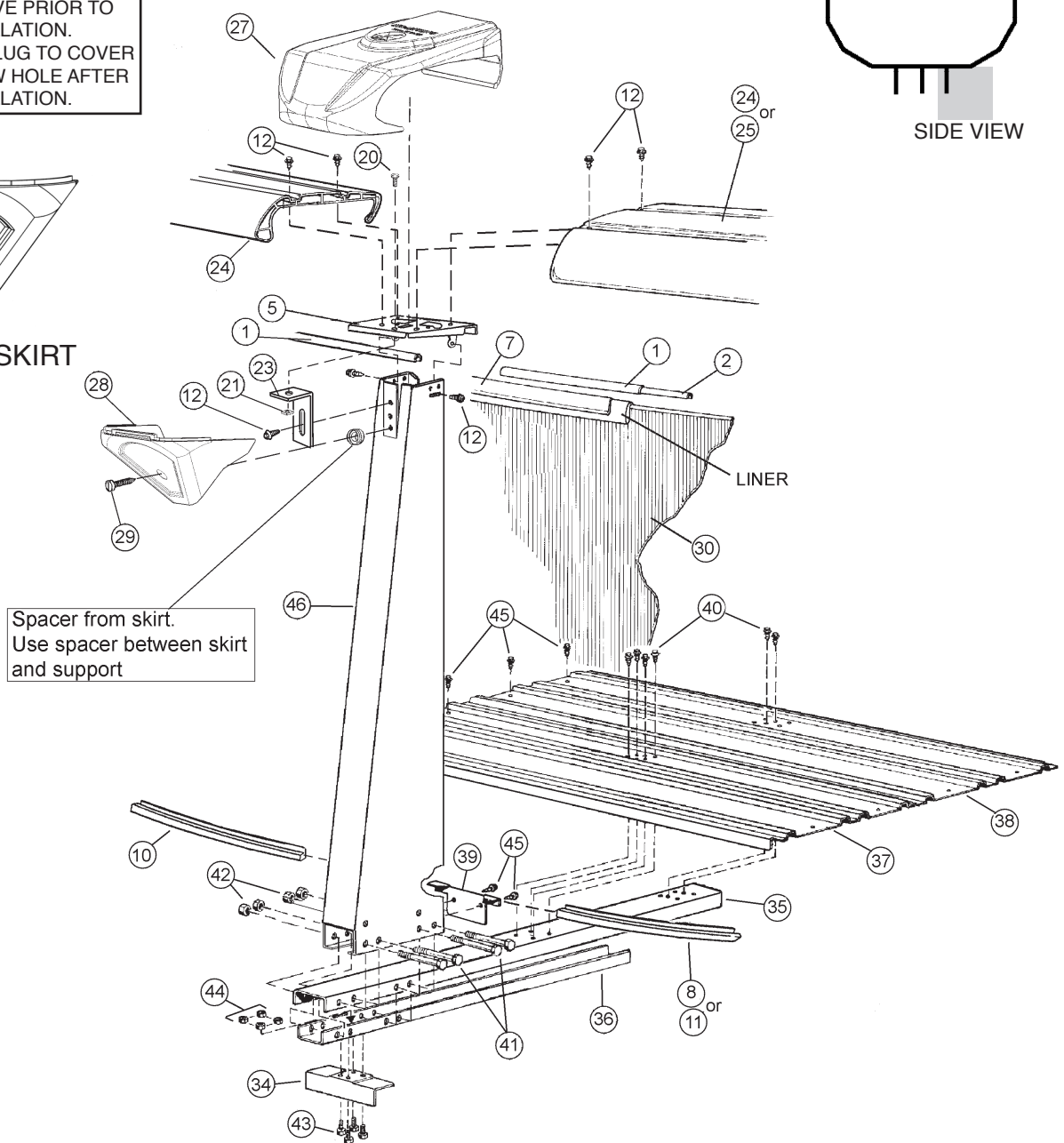

Important! Above-ground pools are designed for swimming and wading only. Do not Dive or Jump! Misuse of your pool may result in crippling injury and/or other dangers to life and health. Do not use slides, diving boards, or any other platform or object which can be used for improper pool entry. Use only an above-ground swimming pool ladder or entry system to enter or exit your pool. Never attempt to swim or reach behind ladders or any other pool entry system. It is the pool owner's responsibility to secure the pool against unauthorized, unsupervised or unintentional entry. It is also the pool owner's responsibility to warn all pool users of the hazards of diving into shallow water: paralyzing injury may result. Always obey all safety rules. Remember, pool safety is everybody's responsibility.

Safety decals and caution information provided with your pool have been endorsed by the U.S. Consumer Product Safety Commission. It is mandatory that the pool owner and installer follow the installation and use directions for all provided safety signs and decals. Juveniles must be supervised at all times by a responsible adult as directed by the USCPSC.

Change of Design: The manufacturer (Hill) expressly reserves the right to change or modify the design and construction of any product in due course of their manufacturing procedures, without incurring any obligation to furnish or install such changes or modifications on products previously or subsequently sold.